

**CADDY®**

**CADDY® ERISTRUT**

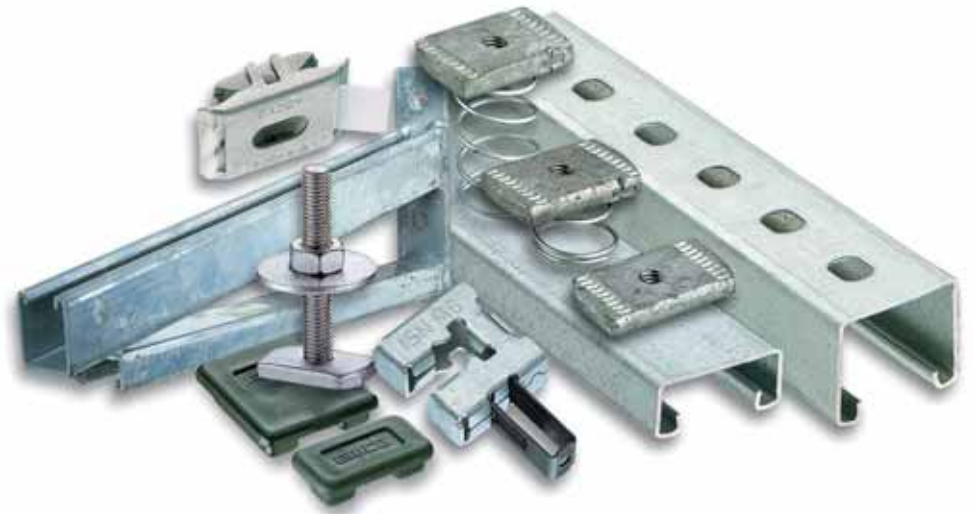

**CADDY® ERISTRUT**

**CADDY® ERISTRUT  
Accessories**

**CADDY®  
Fixings, Fasteners  
and Supports**



**ERICO®**

CADDY® ERISTRUT strut support systems and accessories from ERICO® provide solutions to fixing and fastening problems in the electrical, mechanical and datacomm installation industries.

Structural fixing systems require a high degree of reliability, the kind of reliability only built into products after years of experience in the field.

**CADDY® Fasteners:**

- provide full corrosion protection
- offer a wide range of solutions
- are simple and easy to install
- save time and money



**CADDY® ERISTRUT**

**Profile 41 x 21 DG**

- Thickness 2,5 mm
- Hot dipped galvanised

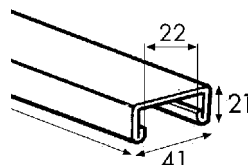

Description	Part No	L m	P	
41x21 DG	ES4121PLX3	3	3	1
41x21 DG	ES4121PLX6	6	3	1

**Profile 41 x 41 AG**

- Thickness 2,5 mm
- Hot dipped galvanised

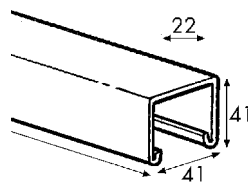

Description	Part No	L m	P	
41x41 AG	ES4141PLX3	3	3	1
41x41 AG	ES4141PLX6	6	3	1

**Profile 41 x 21 Holes on back DB**

- Thickness 2,5 mm
- Hot dipped galvanised

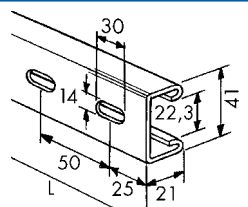

Description	Part No	L m	P	
41x21 DB	ES4121SLOTX3	3	3	1
41x21 DB	ES4121SLOTX6	6	3	1

**Profile 41 x 41 Holes on back AB**

- Thickness 2,5 mm
- Hot dipped galvanised

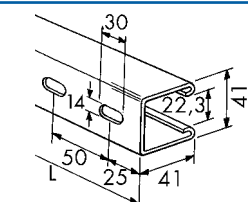

Description	Part No	L m	P	
41x41 AB	ES4141SLOTX3	3	3	1
41x41 AB	ES4141SLOTX6	6	3	1

**Admissible Load Rating in kg**

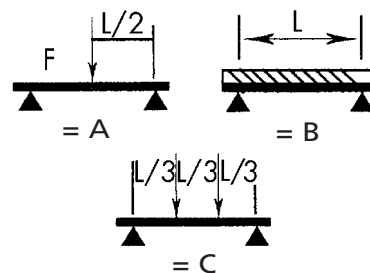

Length    A                    B                    C

Length	A	B	C
<b>DG</b> 41 x 21 x 2.5 mm			
500	128	257	96
1000	64	127	48
1500	42	83	31
2000	30	61	23
3000	19	38	14
6000	5	11	5
<b>AG</b> 41 x 41 x 2.5 mm			
500	404	808	303
1000	201	402	151
1500	133	266	100
2000	99	197	74
3000	64	127	48
6000	26	52	20
<b>DB</b> 41 x 21 x 2.5 mm holes on the back			
500	121	242	91
1000	60	120	45
1500	39	78	30
2000	29	57	22
3000	18	35	14
6000	5	10	4
<b>AB</b> 41 x 41 x 2.5 mm holes on the back			
500	382	763	286
1000	190	380	143
1500	126	251	94
2000	93	186	70
3000	60	120	45
6000	24	48	19

## CANTILEVER ARM SUPPORTS

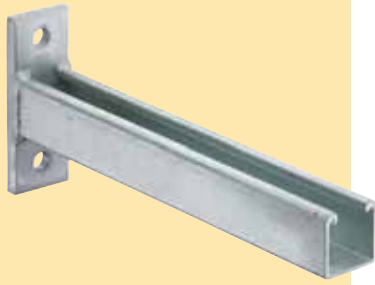

### KHC Cantilever Arm Wall Mounting Bracket

- Welded profile 41 x 41 mm
- Hot dipped galvanised

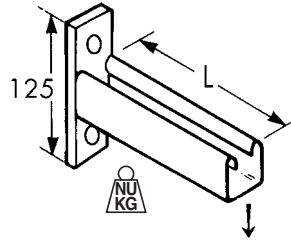

Description	Item	L mm	P	
KH150	KH10C	150	3	1
KH200	KH5C	200	3	1
KH250	KH6C	250	3	1
KH300	KH11C	300	3	1
KH400	KH15C	400	3	1
KH450	KH12C	450	3	1
KH550	KH16C	550	3	1
KH600	KH13C	600	3	1
KH650	KH8C	650	3	1
KH700	KH9C	700	3	1
KH750	KH14C	750	3	1

### Admissible Load Rating in kg

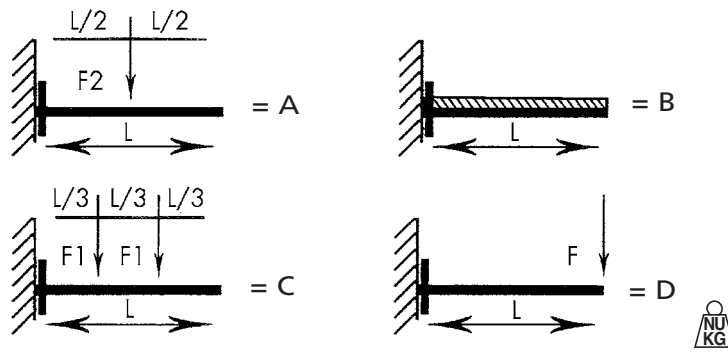

Length	A	B	C	D
150	650	650	325	325
200	480	480	240	240
250	390	390	190	190
300	325	325	162	162
400	240	240	120	120
450	217	277	108	108
550	170	170	88	88
600	162	162	81	81
650	150	150	75	75
700	140	140	70	70
750	130	130	63	63



### ECB Cantilever Arm Wall Mounting Bracket with Brace

- Welded profile 41 x 41 x 2.5 mm
- Brace profile 41 x 21 x 2.5 mm
- Hot dipped galvanised

Description	Item	L mm	P	
ECB150	ECB150	320	3	1
ECB300	ECB300	470	3	1
ECB450	ECB450	635	3	1
ECB600	ECB600	780	3	1

## CADDY® ERISTRUT ACCESSORIES

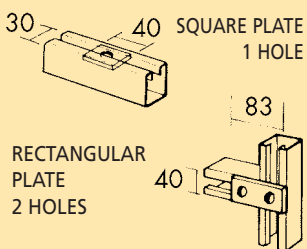

Description	Part No	P	
ZEA 100	387500	3	1

Description	Part No	P	
ZEA 102	387520	3	1

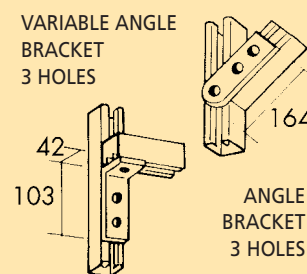
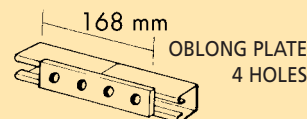

Description	Part No	P	
ZEA 104	387540	3	1

Description	Part No	P	
ZEA 106	387560	3	1

Description	Part No	P	
ZWA 202	387620	3	1

# CADDY® ERISTRUT ACCESSORIES



RIGHT ANGLE BRACKET

Description	Part No	P	
ZEA 107	387570	3	1

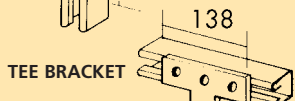

TEE BRACKET

Description	Part No	P	
ZEA 108	387580	3	1

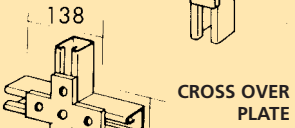

CROSS OVER PLATE

Description	Part No	P	
ZEA 109	387590	3	1

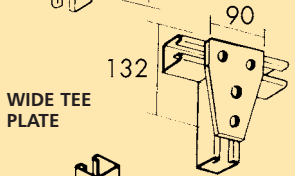

WIDE TEE PLATE

Description	Part No	P	
ZEA 110	387450	3	1

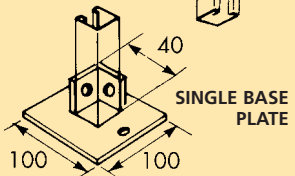

SINGLE BASE PLATE

Description	Part No	P	
ZGA 501	388270	3	1

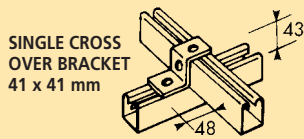

SINGLE CROSS OVER BRACKET  
41 x 41 mm

Description	Part No	P	
ZSA 301	387740	3	1

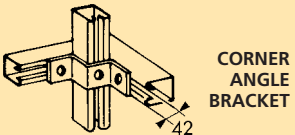

CORNER ANGLE BRACKET

Description	Part No	P	
ZSA 304	388110	3	1

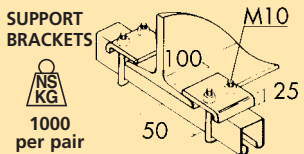

SUPPORT BRACKETS

Description	Part No	P	
ZT 601	313200	3	1

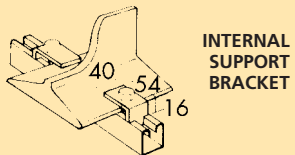

INTERNAL SUPPORT BRACKET

Description	Part No	P	
ZTA 605	388080	3	1

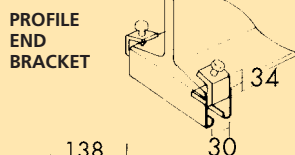

PROFILE END BRACKET

Description	Part No	P	
ZT 606	313270	3	1

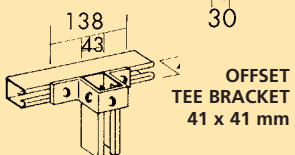

OFFSET TEE BRACKET  
41 x 41 mm

Description	Part No	P	
ZUA 400	387750	3	1

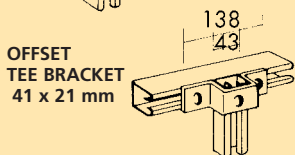

OFFSET TEE BRACKET  
41 x 21 mm

Description	Part No	P	
ZUA 401	387760	3	1

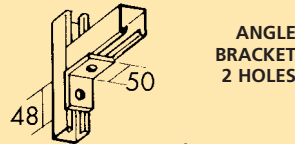

ANGLE BRACKET  
2 HOLES

Description	Part No	P	
ZWA 200	387600	3	1

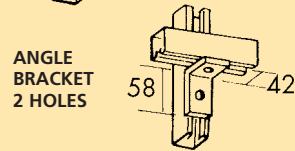

ANGLE BRACKET  
2 HOLES

Description	Part No	P	
ZWA 201	387610	3	1

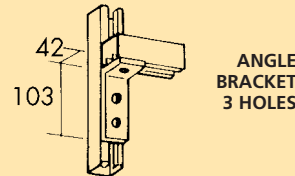

ANGLE BRACKET  
3 HOLES

Description	Part No	P	
ZWA 202	387620	3	1

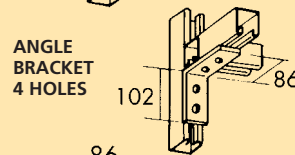

ANGLE BRACKET  
4 HOLES

Description	Part No	P	
ZWA 205	387650	3	1

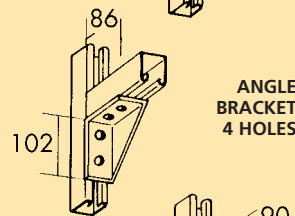

ANGLE BRACKET  
4 HOLES

Description	Part No	P	
ZWA 207	387670	3	1

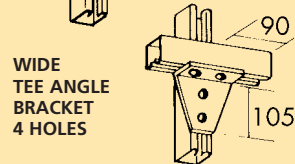

WIDE TEE ANGLE BRACKET  
4 HOLES

Description	Part No	P	
ZWA 209	387690	3	1

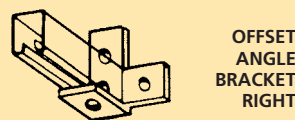

OFFSET ANGLE BRACKET  
RIGHT

Description	Part No	P	
ZWA 214	387890	3	1

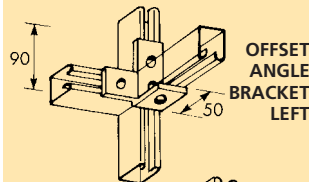

OFFSET ANGLE BRACKET  
LEFT

Description	Part No	P	
ZWA 215	387900	3	1

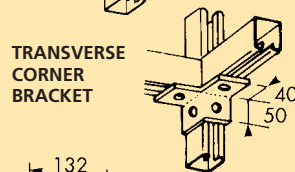

TRANSVERSE CORNER BRACKET

Description	Part No	P	
ZZ 701	388400	3	1

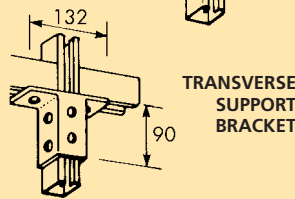

TRANSVERSE SUPPORT BRACKET

Description	Part No	P	
ZZA 702	387720	3	1

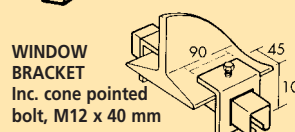

WINDOW BRACKET  
Inc. cone pointed bolt, M12 x 40 mm

Description	Part No	P	
ZZ 704	313870	3	1

## ISN NUT - M6, M8, M10





## Place the ISN directly where you need it

- For example, as a lock nut
- No need to disassemble existing installations
- No need to remove plaster, dirt, etc.
- No need to change threaded rods because of damaged threads
- No need to clean up threads

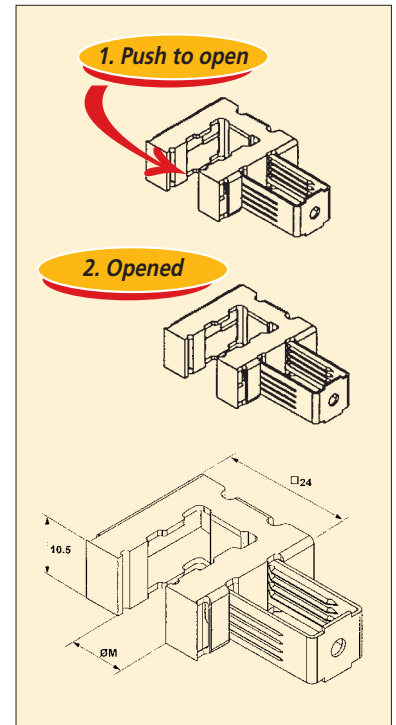

**No more turning, turning, turning, ...**  **Simply lock in the ISN!**



Description	Part No	Ø M	NS KG	P	
ISN M6	187340	M6	75	1	50
ISN M8	187350	M8	100	1	50
ISN M10	187360	M10	100	1	50

- M6, M8, M10 threads
- Patented
- Convenient dispenser box

## CADDY® SLICK STRUT NUT





## The best invention since the spring nut

The CADDY SLICK STRUT NUT is a fast and easy way to fix one threaded rod onto universal strut profiles. Ideal for electrical, plumbing and heating, ventilation and all service applications.

## Installation

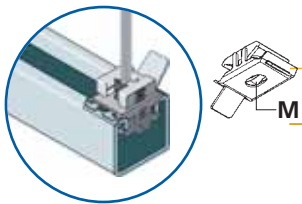
- Locates directly onto strut profile
- Height adjustment possible
- Easy to mount "one handed installation"
- Less "on site wastage"
- Easy to re-locate



Description	Part No	Ø M	Fig. 1-2	NS KG Fig. 3*	Fig. 4	P	
SLICK M6	174460	M6	125	60	70	7	100
SLICK M8	174340	M8	150	60	75	7	100
SLICK M10	174350	M10	150	60	75	7	100
SLICK M12	174550	M12	150	60	75	7	100

\*For fixing direct to the CADDY SLICK STRUT NUT.

CADDY SLICK STRUT NUT can also be combined with the CADDY® ISN NUT.

The CADDY SLICK STRUT NUT is also available with pre-mounted threaded rods, M8 and M10.

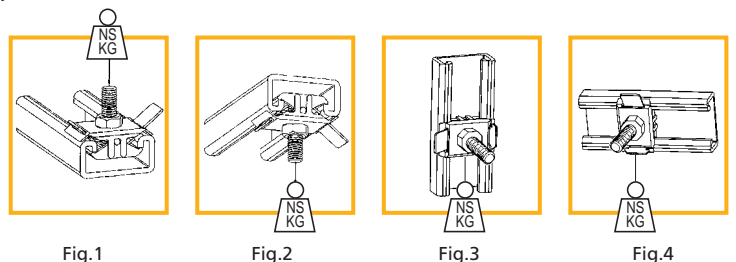



## UM-UD-UA STRUT NUTS

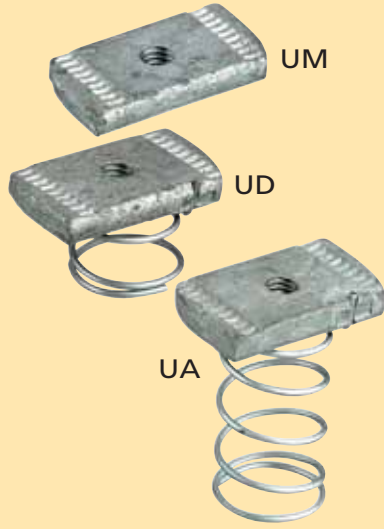

## UM-UD-UA Strut Nuts

- UM: nut for 41 x 41 mm and 41 x 21 mm profiles
- UD: short spring nut for 41 x 21 mm profiles
- UA: long spring nut for 41 x 41 mm profiles
- Thread M6, M8, M10 and M12
- Hot dipped galvanised (stainless steel available upon request)

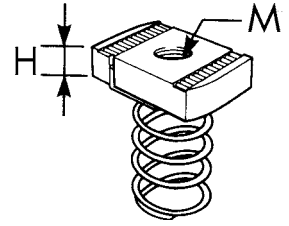
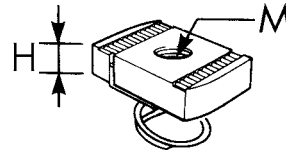
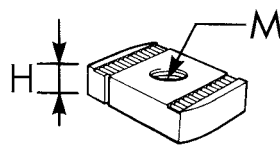

Description	Part No	M mm	H mm	P	
UM506	315000	6	5	3	100
UM608	315010	8	6	3	100
UM810	315020	10	8	3	100
UM812	315030	12	8	3	100

Description	Part No	M mm	H mm	P	
UD506	315040	6	5	3	100
UD608	315050	8	6	3	100
UD810	315060	10	8	3	100
UD812	315070	12	8	3	100

Description	Part No	M mm	H mm	P	
UA506	315080	6	5	3	100
UA608	315090	8	6	3	100
UA810	315100	10	8	3	100
UA812	315110	12	8	3	100

## PRE-MOUNTED NUT TM



## Pre-Mounted Nut TM

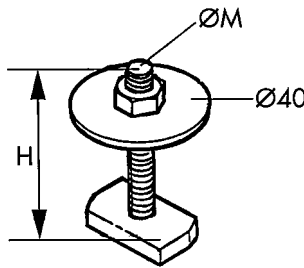

- For CADDY® profile types 41 x 21 mm and 41 x 41 mm
- TM Nuts are hot dipped galvanised

Description	Part No	M	P	
TMN 8x40	590080	8	1	100
TMN 10x40	590090	10	1	100

## PROFILE END CAPS

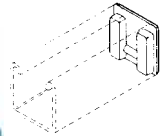

Profile End Caps  
blue PA for profiles  
41 x 41 mm - 41 x 21 mm

Description	Part No	Profiles	P	
ADK421	313305	41x21	10	100

### WARNING

ERICO products shall be installed and used only as indicated in ERICO's product instruction sheets and training materials. Instruction sheets are available at [www.erico.com](http://www.erico.com) and from your ERICO customer service representative. Improper installation, misuse, misapplication or other failure to completely follow ERICO's instructions and warnings may cause product malfunction, property damage, serious bodily injury and death.

### WARRANTY

ERICO products are warranted to be free from defects in material and workmanship at the time of shipment. NO OTHER WARRANTY, WHETHER EXPRESS OR IMPLIED (INCLUDING ANY WARRANTY OF MERCHANTABILITY OR FITNESS FOR A PARTICULAR PURPOSE), SHALL EXIST IN CONNECTION WITH THE SALE OR USE OF ANY ERICO PRODUCTS. Claims for errors, shortages, defects or nonconformities ascertainable upon inspection must be made in writing within 5 days after Buyer's receipt of products. All other claims must be made in writing to ERICO within 6 months from the date of shipment or transport. Products claimed to be nonconforming or defective must, upon ERICO's prior written approval in accordance with its standard terms and procedures governing returns, promptly be returned to ERICO for inspection. Claims not made as provided above and within the applicable time period will be barred. ERICO shall in no event be responsible if the products have not been stored or used in accordance with its specifications and recommended procedures. ERICO will, at its option, either repair or replace nonconforming or defective products for which it is responsible or return the purchase price to the Buyer. THE FOREGOING STATES BUYER'S EXCLUSIVE REMEDY FOR ANY BREACH OF ERICO WARRANTY AND FOR ANY CLAIM, WHETHER SOUNDING IN CONTRACT, TORT OR NEGLIGENCE, FOR LOSS OR INJURY CAUSED BY THE SALE OR USE OF ANY PRODUCT.

### LIMITATION OF LIABILITY

ERICO excludes all liability except such liability that is directly attributable to the willful or gross negligence of ERICO's employees. Should ERICO be held liable its liability shall in no event exceed the total purchase price under the contract. ERICO SHALL IN NO EVENT BE RESPONSIBLE FOR ANY LOSS OF BUSINESS OR PROFITS, DOWNTIME OR DELAY, LABOR, REPAIR OR MATERIAL COSTS OR ANY SIMILAR OR DISSIMILAR CONSEQUENTIAL LOSS OR DAMAGE INCURRED BY BUYER.

Copyright ©2008 ERICO International Corporation. All rights reserved.

CADDY, CADWELD, CRITEC, ERICO, ERIFLEX, ERITECH, and LENTON are registered trademarks of ERICO International Corporation.

**ERICO Australia**  
323 Parramatta Road, Auburn, NSW 2144, Australia  
Telephone: 61-2-9751 8500 • Fax: 61-2-9475 5334

**ERICO Singapore**  
Jurong Industrial Estate, 16 Wan Lee Road, Singapore 627 946  
Telephone: 65 6 268 3433 • Fax: 65 6 268 1389

**ERICO Hong Kong**  
Unit 1, 2nd. Floor, Block A, Po Yip Building, 62-70 Texaco Road,  
Tsuen Wan, New Territories, Hong Kong  
Telephone: 852 2764 8808 • Fax: 852 2764 4486

[www.erico.com](http://www.erico.com)

**ERICO®**

F579B-AAEN F1008LT08AAEN 0064M8